

MERCEDES-BENZ WHEEL ALIGNMENT

CAMERA TECHNOLOGY FOR YOUR WORKSHOP



Powered by  **JOSAM**®

INVEST IN MODERN TECHNOLOGY TO GROW YOUR BUSINESS

- Homologated by Mercedes-Benz for trucks, buses and light commercial vehicles.
- Measurement values integrated into Mercedes-Benz warranty claim sheet.
- Guided measurement procedures according to Mercedes-Benz principles and specifications.

INCREASE YOUR TURNOVER

A quicker and modern way will enable you to diagnose a vehicle in matter of minutes. This will increase your turnover as many vehicles are subject to being adjusted.

Diagnosis could also create spin-off activities such as sales of suspension related spare parts (bushings, tie rods, ball joints, bearings etc.).





MEASURE EVERY VEHICLE FROM V-CLASS TO BUS AND HEAVY DUTY VEHICLES

THE MERCEDES-BENZ Wheel Alignment System with all its different adapters and additions is able to measure every possible commercial vehicle on the market, including the V-Class with Sprinter and Vito.

THE UNIVERSAL WHEEL ADAPTER fits all rim sizes from 14" to 26" with extensions. In combination with the compact frame gauges the system is suitable for measuring everything from light commercial vehicles to the heaviest trucks and buses. As the frame gauges can be altered in width, they can be adapted from narrow to wide bodies.

MEASURING TRAILERS is also easy, as the frame gauges are hung on the chassis using the centerline as reference.









**DIAGNOSE A 6X2 VEHICLE WITH
70%
INCREASED
SPEED**

[DIAGNOSIS]

A SYSTEM IN A CLASS OF ITS OWN

- By putting sensors on the wheels and measuring both forward and backwards, you will be able to measure all possible vehicle combinations that come into the workshop.
- The system is designed to measure and adjust multiple steered vehicles in a simple and accurate way.
- Thanks to its portability the system can be used at every location in the workshop and at the customer's site. This will optimize the flow in your workshop and therefore also your productivity.
- The camera technology enables the system to diagnose frame damages and create report sheets that are accepted by insurance companies.
- A European product developed for European trucks and buses.



INCREASE CUSTOMER VALUE



WHEEL ALIGNMENT HAS A LARGE INFLUENCE ON:

- FUEL ECONOMY
- TIRE COST
- DRIVING COMFORT
- SAFETY ON THE ROAD

CALCULATION EXAMPLE 1

Fuel cost reduction: 3%
Mileage/year: 150 000 km
Fuel price: 1.1 EUR/litre
Fuel consumption: 3.5 litres/10 km
Total cost reduction/year:
 $0.03 * 150\ 000 * 1.1 * 0.35 = 1\ 733\ \text{EUR}$

CALCULATION EXAMPLE 2

Premature tire change, 2 tires/year
Tire cost: 350 EUR/tire
Cost reduction/year:
 $350 * 2 = 700\ \text{EUR}$



Estimated
fuel/tire cost
reduction per year:
2 433 EUR*

* Cost for wheel alignment not included in the calculation

Source, fuel cost reduction:
Survey performed during 2013 on 500 vehicles from 12 different companies
by the research institute TNO, Holland

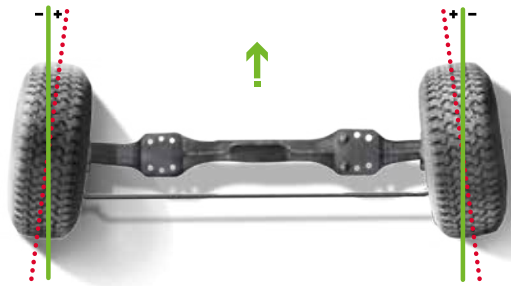

Toe



Camber

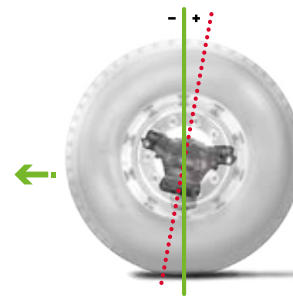

Caster

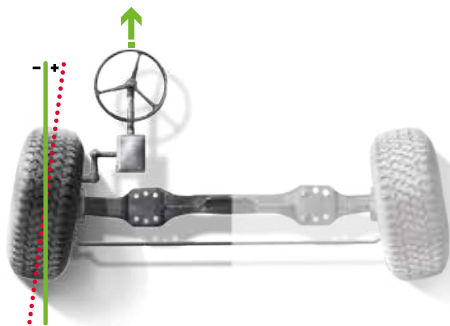

Steering gear middle position



KPI

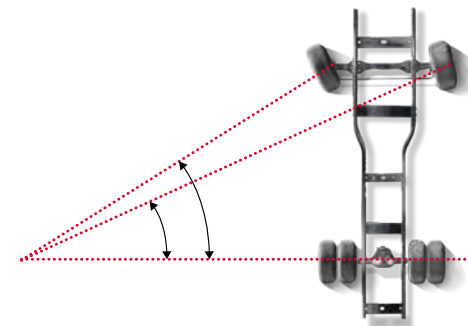

Toe-out on turn



Maximum turn

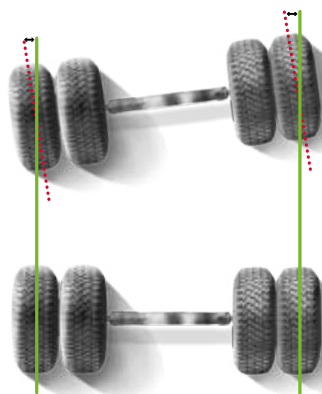

Parallelism

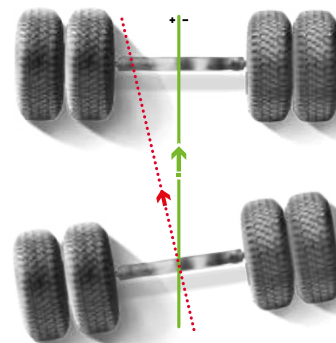

Out of square

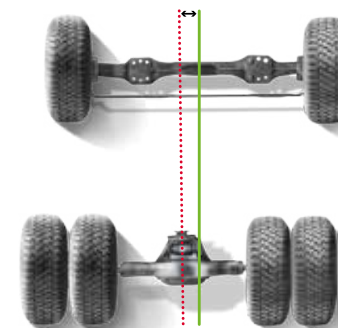

Offset

WHY JOSAM SHOULD BE YOUR BUSINESS PARTNER

- The same camera technology is also used in all Mercedes Benz truck and axle assembly plants globally.
- For 45 years, Josam has been a global supplier for wheel alignment equipment with its focus on commercial vehicles only.
- Josam was the first wheel alignment equipment to be homologated for Mercedes Benz trucks and buses in 1985.
- Our wheel alignment competence is spread globally through our training centres.



YOUR HOMOLOGATED EQUIPMENT COMPRISES

MERCEDES-BENZ CA MB K/74200

#	ARTICLE #	ORDER #	PCS.	DESCRIPTION
1	AM1227-1 A	10234	1	Magnet bracket for frame, right
2	AM1227-2 A	10235	1	Magnet bracket for frame, left
3	AM1622	10360	2	Front adapter for Mercedes
4	TC-1029	71349	2	Magnet bracket for frame gauge
5	JT510	12029	1	Adapter for bumper
6	JT295 A	14478	4	Turntable with non-friction plate JT280
7	CA3850	74850	1	Cabinet for equipment MB, with PC hardware
8	TC-361	70009	1	USB cable
9	TC-233-10	70032	1	Reflective Target FL
10	TC-233-20	70033	1	Reflective Target FR
11	TC-233-30	70034	1	Reflective Target RL
12	TC-233-40	70035	1	Reflective Target RR
13	TC-395	70040	1	Charging cradle
14	12860	70546	4	Wooden plate for height compensation
15	CA1000	72000	4	Wheel adapter spider 14"-22.5"
16	CA1004	72004	2	Compact frame gauge with hangers
17	CA ANGLE K A	75661	1	Additional kit for inclinometer
18	CA1009 A	75642	1	Wireless server
19	CA1010 A	75640	2	Camera sensor
20	CA1034	72034	6	Extension leg for spider wheel adapter 26"
21	CA3202	74202	1	Software, tailor-made for Mercedes



RECOMMENDED ACCESSORIES



2 x AM268 A / 13762

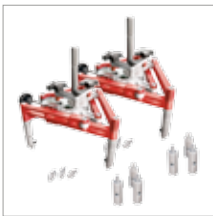

2 x CA1000 / 72000



2 x CA1006 / 72006



1 x CA BUS K / 72244



6 x CA1034 / 72034



1 x AM48 A / 10579



1 x JT167 / 11921



2 x JT485 / 12017



2 x JT5-8 / 12046

... WHICH WILL GIVE YOU

- Modern, ergonomic and user-friendly measuring technology covering today's vehicles.
- Fast and simple measuring procedures which increase your productivity on wheel alignment compared to a conventional nondigital system.
- Robust industrial design and in-built calibration functions to keep your equipment maintenance at a minimum cost.
- Process controlled and guided software, reducing your operator dependency.
- Opportunities to sell wheel alignment services.



Cam-aligner Mercedes-Benz upgrade from laser AM, CA MB UPG AM/75880

#	Article #	Order #	Pcs.	EN	SE	DE
1	TC-361	70009	1	USB cable	USB-kabel	USB-Kabel
2	CA1009 A	75642	1	Wireless server	Trådlös mottagare	Empfänger
3	TC-216-10	70003	1	Reflective Target FL	Reflekerande måttavla VF	Reflektierende Mess-Skala VL
4	TC-216-20	70004	1	Reflective Target FR	Reflekerande måttavla HF	Reflektierende Mess-Skala VR
5	TC-216-30	70005	1	Reflective Target RL	Reflekerande måttavla VB	Reflektierende Mess-Skala HL
6	TC-216-40	70006	1	Reflective Target RR	Reflekerande måttavla HB	Reflektierende Mess-Skala HR
7	TC-395	70040	1	Charging cradle	Laddstation	Ladegerät
8	CA ANGLE K A	75661	1	Additional kit for inclinometer	Tilläggsats för inklinometer	Ergänzungssatz für Inclinometer
9	CA1010 A	75640	2	Camera sensor	Kamerasensor	Kamerasensor
10	CA3202	74202	1	Software, standard	Mjukvara, standard	Software, standard
11	CA1087	72087	1	Case for system parts	Förvaringsväska för systemdelar	Kiste für Systemteile

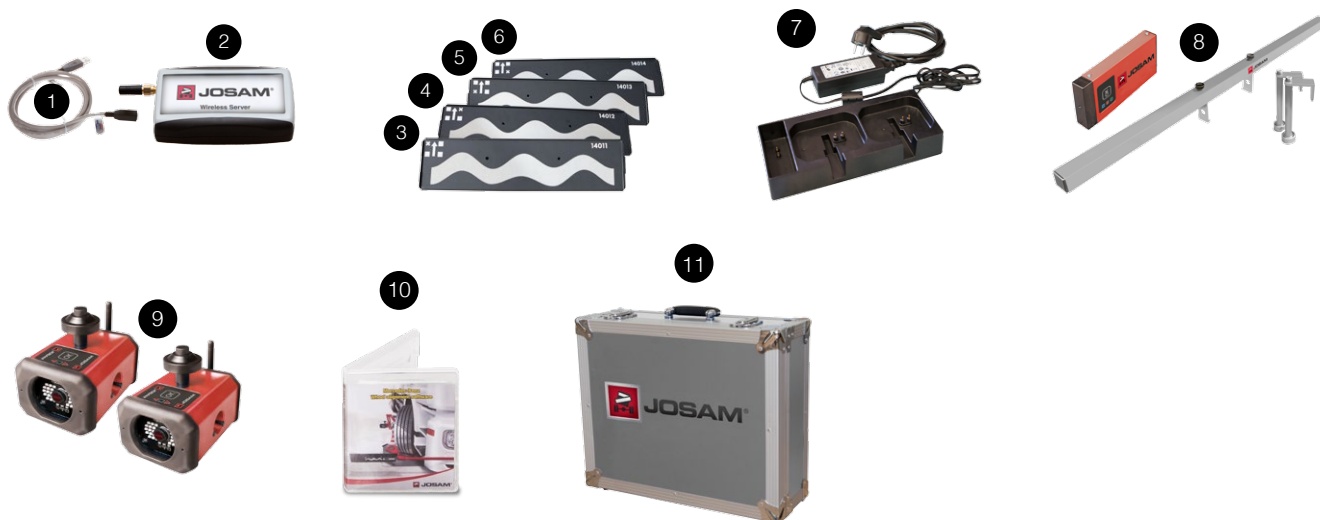

Note: 4 pcs. of sliding turnplates JT295 A and 4 pcs. of compensation plates 12860 are mandatory.

Obs: 4 st vridplattor JT295 A och 4 st kompensationsplattor 12860 krävs.

Hinweis: 4 Stück Drehplatten JT295 A und 4 Stück Kompensierungsplatten 12860 sind notwendig.



Cam-aligner Mercedes-Benz upgrade from truckaligner, CA MB UPG TA/75881

#	Article #	Order #	Pcs.	EN	SE	DE
1	TC-361	70009	1	USB cable	USB-kabel	USB-Kabel
2	CA1009 A	75642	1	Wireless server	Trådlös mottagare	Empfänger
3	TC-216-10	70003	1	Reflective Target FL	Reflekterande måttavla VF	Reflektierende Mess-Skala VL
4	TC-216-20	70004	1	Reflective Target FR	Reflekterande måttavla HF	Reflektierende Mess-Skala VR
5	TC-216-30	70005	1	Reflective Target RL	Reflekterande måttavla VB	Reflektierende Mess-Skala HL
6	TC-216-40	70006	1	Reflective Target RR	Reflekterande måttavla HB	Reflektierende Mess-Skala HR
7	TC-395	70040	1	Charging cradle	Laddstation	Ladegerät
8	CA ANGLE K A	75661	1	Additional kit for inclinometer	Tilläggsats för inklinometer	Ergänzungssatz für Inclinometer
9	CA1010 A	75640	2	Camera sensor	Kamerasensor	Kamerasensor
10	CA3202	74202	1	Software, standard	Mjukvara, standard	Software, standard
11	CA1087	72087	1	Case for system parts	Förvaringsväska för systemdelar	Kiste für Systemteile
12	AM5-1750 A	10586	2	Gauge extension 1750 mm	Mätstång 1750 mm	Mess-Stange 1750 mm
13	AM5-1750 B	10587	2	Gauge extension 1750 mm with bubble	Mätstång 1750 mm med libell	Mess-Stange 1750 mm mit Libelle
14	12189	70075	4	Axle (Spider version) for JOSAM wheel adapter	Axel (Spider-version) för JOSAM-hjuladapter	Achse (Spider-Version) für JOSAM-Radhalter
15	AM1609	10356	2	Knob	Ratt	Knauf

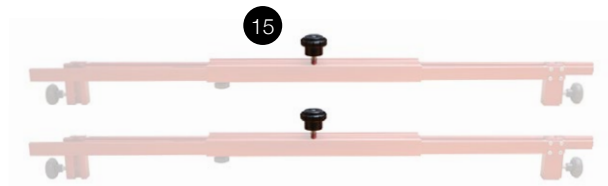
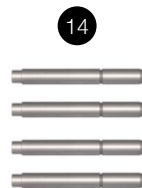
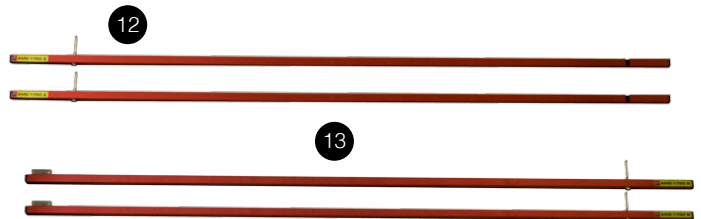
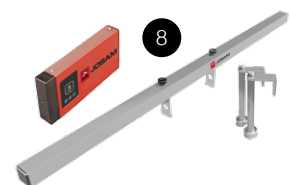
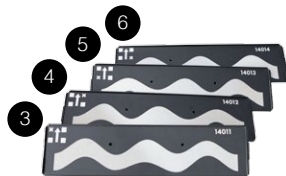

Note: 4 pcs. of sliding turnplates JT295 A and 4 pcs. of compensation plates 12860 are mandatory.

Obs: 4 st vridplattor JT295 A och 4 st kompensationsplattor 12860 krävs.

Hinweis: 4 Stück Drehplatten JT295 A und 4 Stück Kompensierungsplatten 12860 sind notwendig.



Recommended accessories Rekommenderade tillbehör Empfohlenes Zubehör

1	AM268 A	13762	2	Non friction plate	Antifriktionsplatta	Antifriktionsplatte
2	CA1000	72000	2	Wheel adapter spider 14"-22.5"	Hjuladapter spider 14"-22,5"	Radhalter Spider 14"-22,5"
3	CA1006	72006	4	Magnet wheel adapter	Magnethjuladapter	Magnetradhalter
4	CA1034	72034	6	Extension leg for spider wheel adapter 25.5"	Förlängningsben för spider hjuladapter 25,5"	Verlängerung für Radhalter Spider 25,5"
5	CA BUS K	72244	1	Additional kit for buses	Tilläggsats för bussar	Ergänzungssatz für Busse
6	AM48 A	10579	1	Adapter for trailer tow bar	Adapter för släpvagnsögla	Adapter für Zuggabel
7	JT167	11928	1	Bracket for "King-Pin"	Fäste för "King-Pin"	Halter für "King-Pin"
8	JT485	12017	2	Stabilizer	Gungskydd	Feststelleadapter
9	JT5-8	12046	2	Hanger 870 mm	Upphångningsstag 870 mm	Aufhänge-Stange 870 mm
10	JT295 A	14478	4	Turntable with non-friction plate JT280	Vridplatta med antifriktionsplatta JT280	Drehplatte mit Antifriktionplatte JT280
11	12860	70546	4	Wooden plate for height compensation	Träplatta för höjdkompensation	Holzplatte für die Kompensierung der Höhe

Table continues on next page
Tabellen fortsätter på nästa sida
Tabelle weiter auf der nächsten Seite

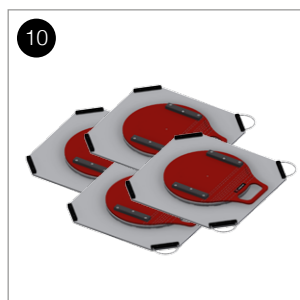
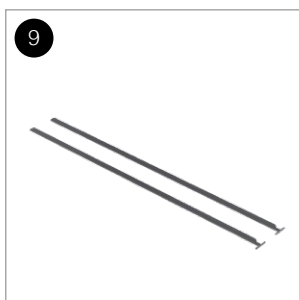
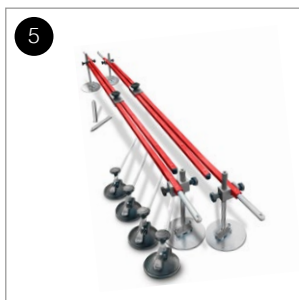
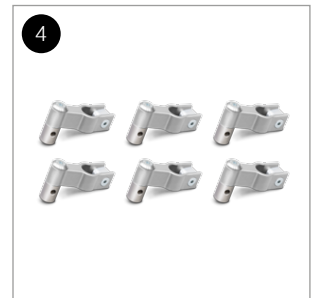



12	TC-416	70044	4	Reference blocks	Referensblock	Referenzblock
13	16776	70114	1	Sticker kit for multi axle roll	Dekalsats för fleraxelrullning	Aufklebersatz für Multiachse-Roll



For multi-roll, four reference blocks TC-416 and one sticker kit 16776 is needed.

För fleraxelrullning krävs fyra referensblock TC-416 och en dekalsats 16776.

Für Multiachse-Roll, vier Referenzblock TC-416 und ein Aufklebersatz 16776 sind notwendig.

Important! Multi-roll function may not be used for warranty claims.

Viktigt! Fleraxelrullning får inte användas i garantiärenden.

Wichtig! Multiachse-Roll darf nicht für Garantieansprüche verwendet werden.



**WE KNOW THAT THE PRODUCT IS NEVER BETTER
THAN THE SUPPORT AND TRAINING PROVIDED.**

AFTER 45 YEARS IN THIS BUSINESS WE HAVE THE
ABSOLUTE BEST SUPPORT AND TRAINING CAPABILITY IN
THE INDUSTRY. THIS WILL ENSURE THAT YOUR INVESTMENT
IN OUR EQUIPMENT IS SUSTAINABLE.

REPRESENTATIVE:

AES

AUTOMOTIVE EQUIPMENT SOLUTIONS

MANUFACTURER:

CAR-O-LINER®

 **JOSAM®**

AES UK • Unit 4, All Saints Ind. Est, WF8 2ST

Tel: +01977 600 688

E-mail: info@aesuk.com • Internet: a-e-s-uk.co.uk